









EQF3000

EQUIPGARAGE

Sollevatore elettro-idraulico a doppia forbice a profilo super-ribassato 
Extra-low-profile hydraulic scissor lift 
Pont à ciseaux super-surbaissé 
Elevador hidráulico de tijera de perfil súper-bajo 





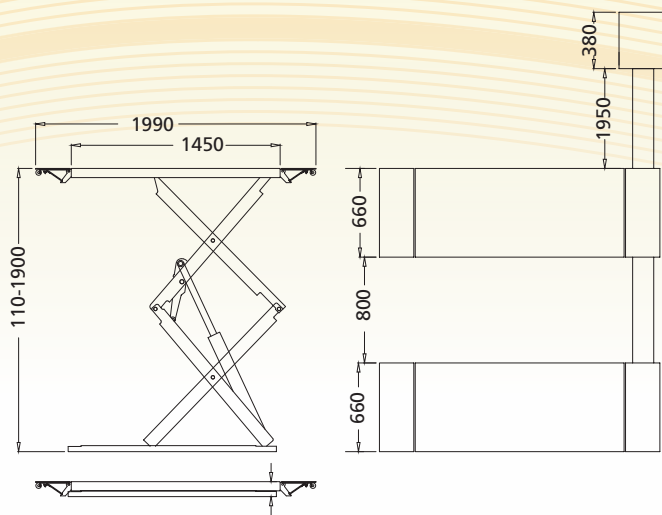





-  **Rampette di salita e discesa di facile movimentazione • Sincronismo idraulico delle pedane • Sicurezza idraulica in caso di sovraccarico Sicurezza idraulica in caso di rottura dei tubi • Regolazione automatica della discesa • Comandi uomo presente, 24V • Serie 4 tamponi in gomma • Segnale acustico ultimo tratto di discesa**
-  **Easy to handle drive-on and drive-off ramps • Hydraulic synchronization of platforms • Overload safety-valve Safety-valve in case of sudden loss of pressure • Automatic lowering control "Dead man" controls 24V • Set of 4 rubber pads • 'Buzzer' on last portion of descent**
-  **Easy to handle drive-on and drive-off ramps • Hydraulic synchronization of platforms • Overload safety-valve Safety-valve in case of sudden loss of pressure • Automatic lowering control "Dead man" controls 24V • Set of 4 rubber pads 'Buzzer' on last portion of descent**
-  **Rampas de subida y bajada fáciles de desplazar • Sincronización hidráulica de las plataformas • Seguridad hidráulica contra sobrecarga • Seguridad hidráulica en caso de rotura tubos • Seguridad mecánica de cremallera • Regulación automática del descenso • Mandos de hombre presente, 24V • Juego de 4 tacos en goma • Señal acústica último tramo de descenso**



Dati tecnici / Technical data / Caractéristiques techniques / Datos técnicos

				EQF3000
Funzionamento	Operation	Fonctionnement	Funcionamiento	Elettroidraulico / Electro-hydraulic Électrohydraulique / Electro-hidráulico
Portata	Capacity	Capacité	Capacidad	3.000 kg
Peso	Weight	Poids	Peso	880 kg
Salita/Discesa	Lifting/lowering	Levage/descent	Subida/bajada	30/30s
Altezza di sollev.	Lifting height	Hauteur de levage	Altura de elevación	1900 mm
Motore	Motor	Puissance moteur	Motor	2,2 kW - 400 V/50 Hz 3 ph
				1 pz art EQF3000 - kg 850,00 - cm 200x75x60
				2 pz art EQF3000 - kg 1700,00 - cm 200x75x70 + 1 PLT. cm 90x52x120

-  **Installazione standard sopra pavimento • Altezza minima: 110 mm • Facile accesso anche con vetture ribassate**
-  **Surface mounted version as a standard • Minimal height: 110 mm • Easy to drive-over even with low cars**
-  **Version installée sur sol est standard • Hauteur minimum: 110 mm • Accès très facile même avec voitures très basses**
-  **Instalación estándar sobre suelo • Altura mínima: 110 mm • Fácil acceso también con vehículos de perfil bajo**
-  **Doppio circuito idraulico di sicurezza • Coppia di cilindri volumetrici sotto ciascuna pedana e sicurezza meccanica aggiuntiva**
-  **Double hydraulic system • Double volumetric cylinder under each platform and mechanical safety lock**
-  **Système hydraulique double • Double vérin hydraulique sous chaque plate-forme et système mécanique de sécurité**
-  **Doble circuito hidráulico de seguridad • Pareja de cilindros volumétricos debajo de cada plataforma y seguridad mecánica**

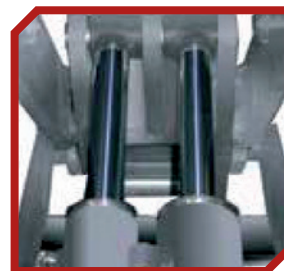

Ufficio / Office

VERTIKAL EUROPE SRL
Via Puccini, 12 - 36040 Brendola (VI) ITALY

Tel. ++ 39 0444 1454563

 info@equipoil.eu

Magazzino / Warehouse

VERTIKAL EUROPE SRL
Via Chemello, 3 - 36075 Montecchio Maggiore (VI) ITALY

 www.equipoil.eu